

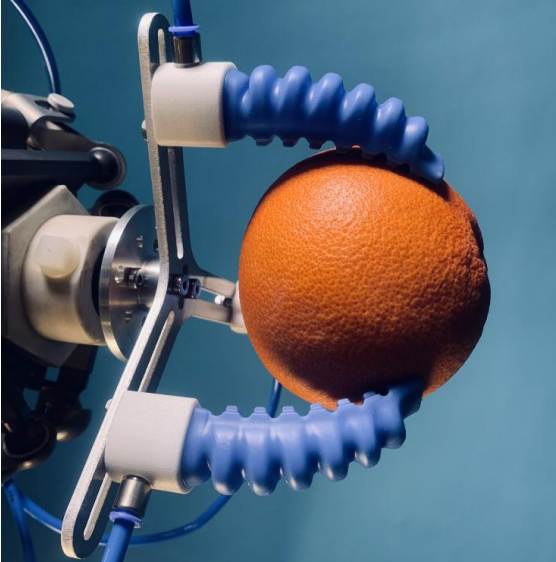

The modular design system
for flexible gripping

Product Catalog 2022



20 SoftGripping GorillaFingers

Made for:

- handling large and heavy goods up to 5 kg
- handling bags and net-packed goods
- goods that profit from gripping with a large surface area

3 SoftGripping Fingers

Made for:

- handling of small to medium-sized delicate goods
- Weights up to 1 kg
- Pick&place applications in confined spaces

SoftGripping - Your Individual Gripper

Configure your individual gripper within minutes with the modular system of SoftGripping. The pneumatically powered elastic gripper allow easy, robust and very light designs. The soft and adaptive surfaces ensure safe and careful gripping of different shaped products.

If your application needs a special design, we are happy to develop a customized gripping system for you and support you in the entire automation process. The design and manufacturing method of SoftGripping allows a fast and cost-effective customization.

Let's find the perfect solution for your individual gripping needs.

Content

4

Elastic Gripping Fingers

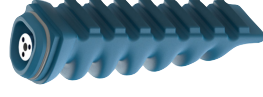

6

SoftGripper



16

SoftActuators

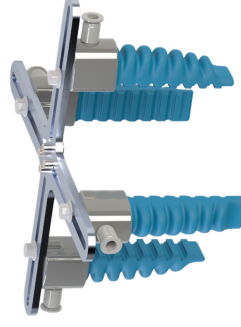

24

Pneumatics



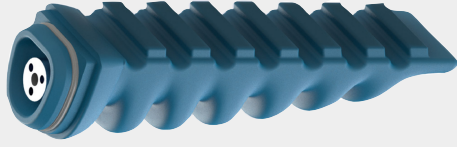
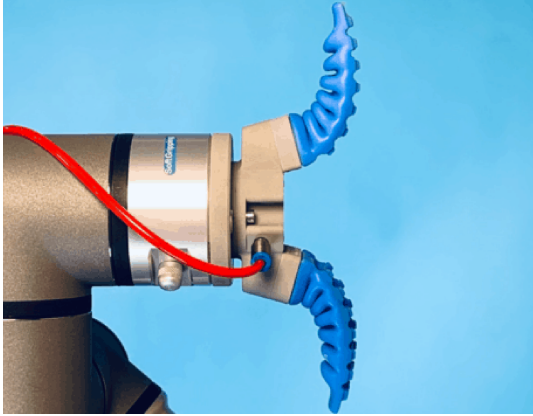
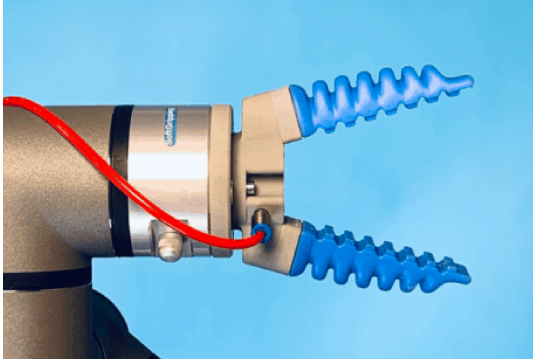
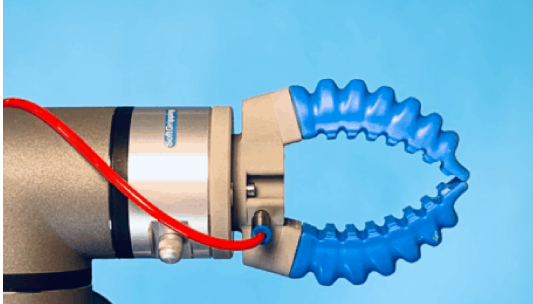

Finger material	Silicone FDA
Mass	20 g
Pressure range	-0.3 ... 1.0 bar
Gripping force	5 N
Durability @1.0 bar 0.5 Hz	>10 million cycles
Gripping speed	<50 ms

Elastic Gripping Finger

The gripping fingers consist of a specially shaped silicon shell, which grips in dependence to the air pressure inside. By applying pressure the fingers close and grip an object carefully. Using vacuum the gripper can be spreaded.

The size of the fingers is inspired by human fingers. Most of the products we want to hold in our hands were once designed to be grasped by human hands - one of the most effective and flexible gripping tool.

Special emphasis in the development process was placed on the durability. Due to an optimized shape and a special developed material more then 10 million gripping cycles can be done.

Get more information!



- Safe collaboration
- Fault tolerant gripping
- High-speed capable
- Optimized durability
- FDA approved material
- Optional: detectable material available
- Gripping differently shaped products with one gripper

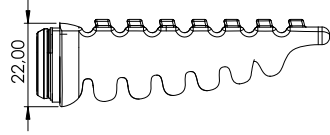
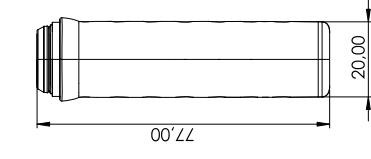

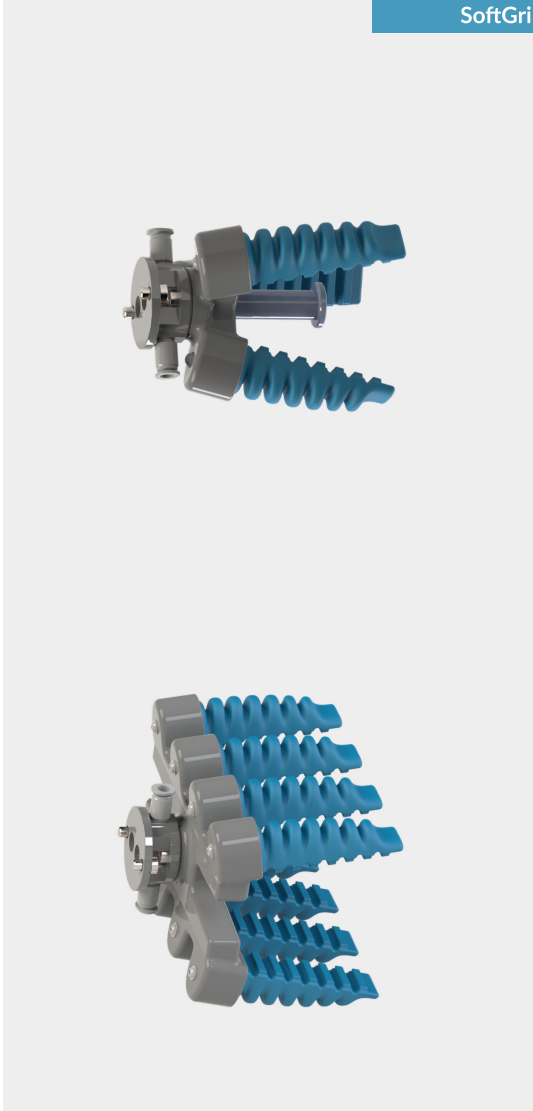
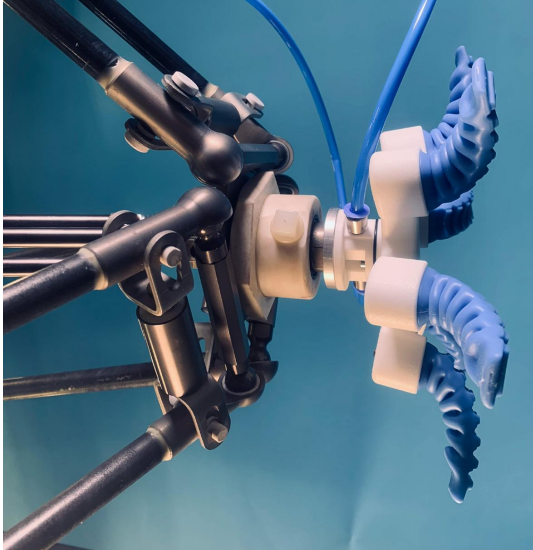
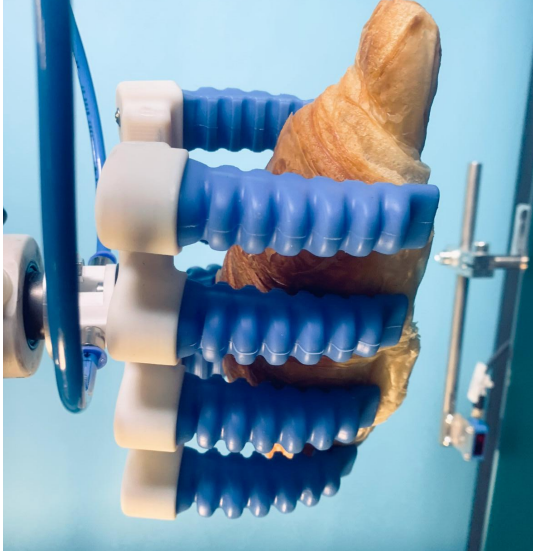

SoftGripper

The SoftGrippers are lightweight, easy to operate and have no sharp edges. They adapt to the shape of any object without damaging the surface. The main advantages are the low weight, the gripping speed and the capability to work with all kinds of objects. Our pneumatically driven fingers are made of FDA-approved silicon rubber. We guarantee a lifetime of more than 10 million cycles at 1 bar pressure.

Adapters are available for any robot on the market. The shape of the gripping object determines the base, which is an essential part of the gripper. A circular object needs a centric base, a long object a parallel one.

You can choose one of our standard gripper with a suitable number of fingers, their arrangement and orientation. With these standard grippers you can handle most objects. For special applications, we will gladly design a completely individual base for your task in shortest time.

You will be surprised how safe and easy one SoftGripper can handle a broad range of objects due to its flexibility. So it is not necessary to have different grippers for differently shaped objects.

Additionally a vacuum suction cup can be mounted centrally to support the gripping process.



- Integrated and very light design
- Ideal for gripping differently shaped objects
- Hygienic design
- Centric and parallel grippers available
- Connector for an optional suction cup or spacer
- Ideal for handling of food and sensitive objects
- High speed gripping with delta robots
- Customized grippers available (number of fingers and finger orientation)

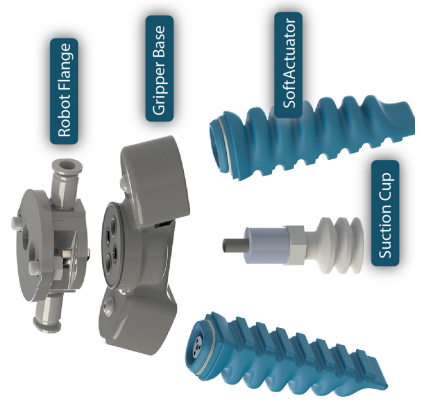

Selection Guide for your Individual SoftGripper

R31 Robot Flange



R31
ISO 9409-A31,5



R50
ISO 9409-A50

You have a different robot flange? Contact us!
We can deliver the right adapter for you.

D15 Angle of the Finger Orientation

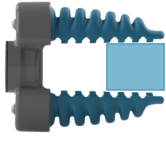

D0
0° for rectangular objects

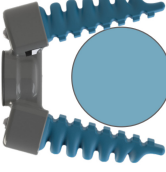

D15
15° or different angles
for round objects

A67

A67 Distance between the Fingers

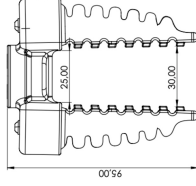

A30
Choose the distance
corresponding to
your object size.



F6
Choose the number of the
finger corresponding to the
size and weight of your
object: 1 Finger = 150 g

A Parallel or Centric Gripper

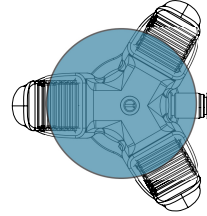

C
Centric gripper for
round objects

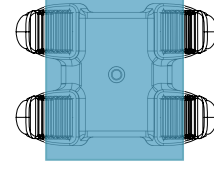

P
Parallel gripper for
rectangular objects

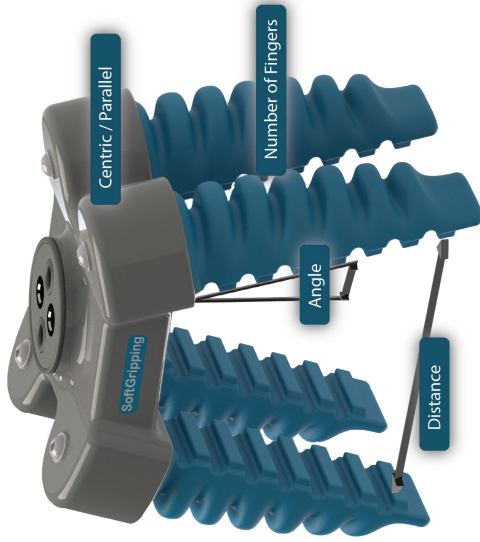

Configure your Individual SoftGripper

R31	Robot Flange
D15	Angle of the Finger Orientation
A67	Distance between the Fingers
S60	Finger Material
F4	Number of the Fingers
P	Parallel or Centric Gripper
H	Hygienic or Normal Gripper
SG	

Beside our standard grippers you can freely configure your customized gripper. Simply choose the number of fingers, their orientation and distance - according to your gripping objects and process. Choose the hygienic version to handle food.

Thanks to the design and manufacturing process your individual SoftGripper can be produced within two weeks.

Just follow the selection guide to specify your gripper and the article number.

You need support in your selection or design process? Just contact us. We are happy to help.

2-Finger Parallel SoftGripper

Art.No. SG.IN.P.F2.S60.Axx.Dxx
Mass 110 g

Typical Gripping Objects

Rectangular or cubic
Feed size 5 mm - 120 mm
Weight < 300 g

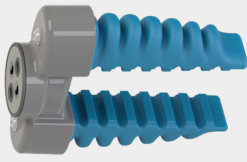

SG.IN.P.F2.S60.A30.D0

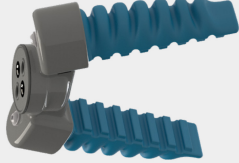

SG.IN.P.F2.S60.A67.D15

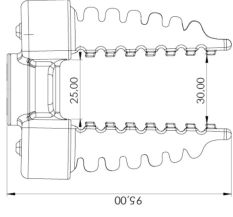

SG.IN.P.F2.S60.A30.D0

0° Cone Angle

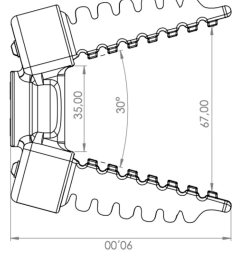

SG.IN.P.F2.S60.A67.D15

15° Cone Angle

3-Finger Centric SoftGripper

Art.No. SG.IN.C.F3.S60.Axx.Dxx
Mass 190 g

Typical Gripping Objects

Circular or cylindrical
Feed size 5 mm - 120 mm
Weight < 450 g

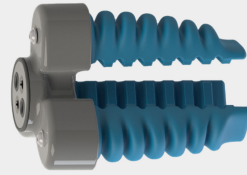

SG.IN.C.F3.S60.A30.D0

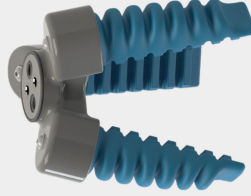

SG.IN.C.F3.S60.A70.D15

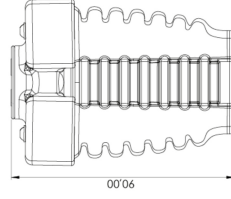

SG.IN.C.F3.S60.A30.D0

0° Cone Angle

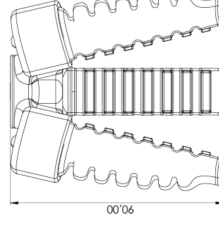

SG.IN.C.F3.S60.A70.D15

15° Cone Angle

4-Finger Parallel SoftGripper

Art.No. SG.IN.P.F4.S60.Axx.Dxx
Mass 200 g

Typical Gripping Objects

Rectangular or cubic
Feed size 5 mm - 120 mm
Weight < 600 g



SG.IN.P.F4.S60.A30.D0

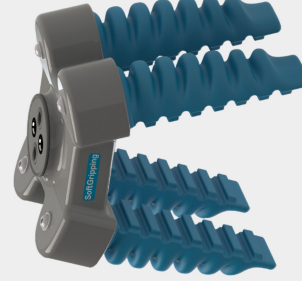

SG.IN.P.F4.S60.A67.D15

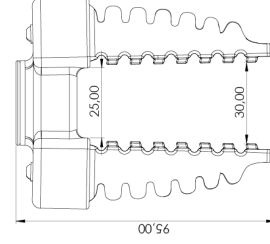

SG.IN.P.F4.S60.A30.D0

0° Cone Angle

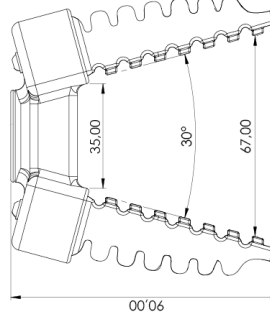

SG.IN.P.F4.S60.A67.D15

15° Cone Angle

6-Finger Centric SoftGripper

Art.No. SG.IN.C.F6.S60.A100.D10
Mass 300 g

Typical Gripping Objects

Rectangular or cubic
Feed size 5 mm - 120 mm
Weight <600 g

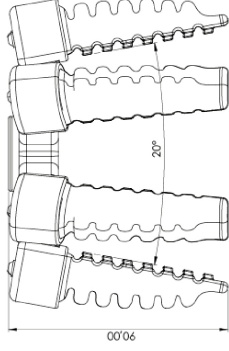
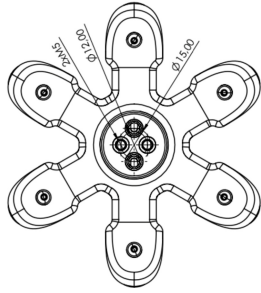
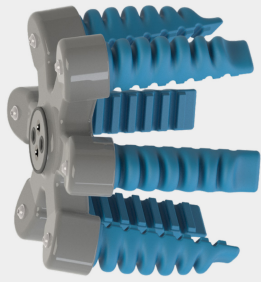

6-Finger Parallel SoftGripper

Art.No. SG.IN.P.F6.S60.A67.D15
Mass 460 g

Typical Gripping Objects

Rectangular or cubic
Feed size 40 mm - 120 mm
Weight <1200 g

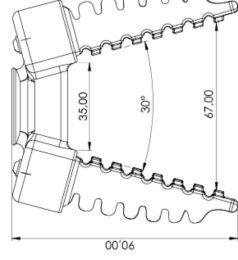
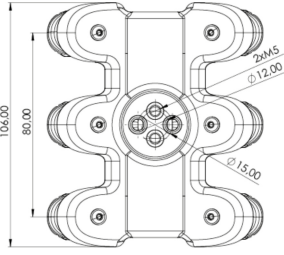

10° Cone Angle

8-Finger Parallel SoftGripper

Art.No. SG.LL.8P.50.80D.G1
Mass 460 g

Typical Gripping Objects

Rectangular or cubic
Feed size 40 mm - 120 mm
Weight <1200 g

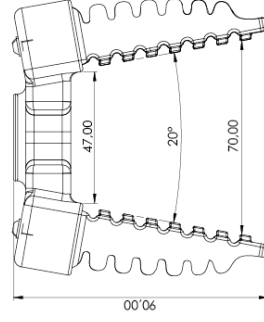
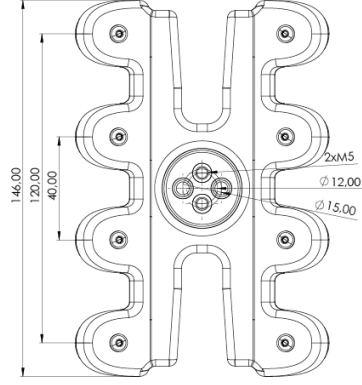
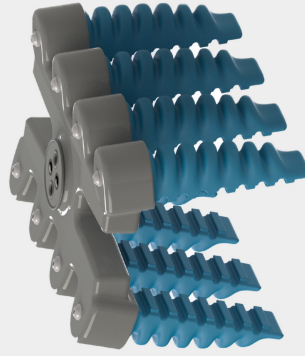

10° Cone Angle

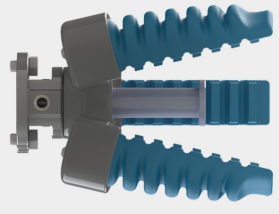

Spacer for Small Objects

Art.No. SG.SP.M5.40.01

Safe gripping and avoiding of sliding upwards of small gripping objects.

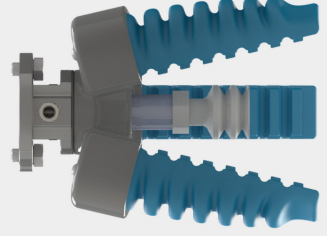
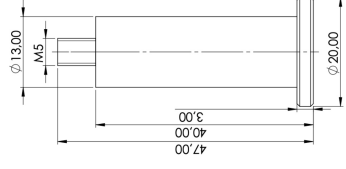

Suction Cup Extender with G1/8 thread

Art.No. SG.SP.M5.40.01

Suction cups can be used to add gripping force for flat objects.

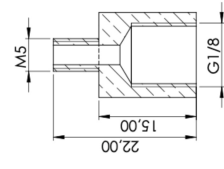

SoftGripper Construction Kit

Do you have various applications and would like to test the versatility of SoftGripping? You can do it with the Construction Kit!

The Construction Kit includes:

- 6x SoftGripping Finger
- 2 Finger Gripper Base
- 3 Finger Gripper Base
- 4 Finger Gripper Base
- 6 Finger Gripper Base
- Suction Cup
- Spacer
- Pneumatic Accessories
- Roboter adapter

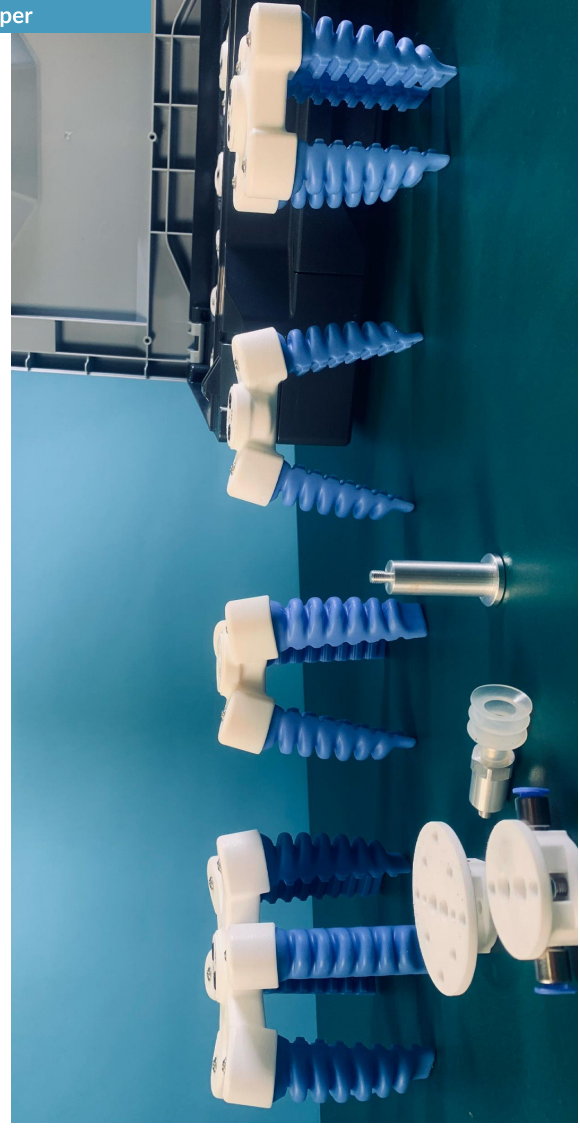
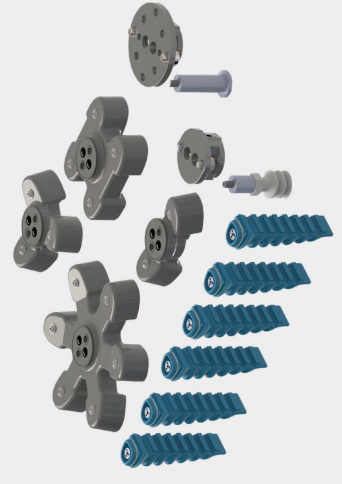

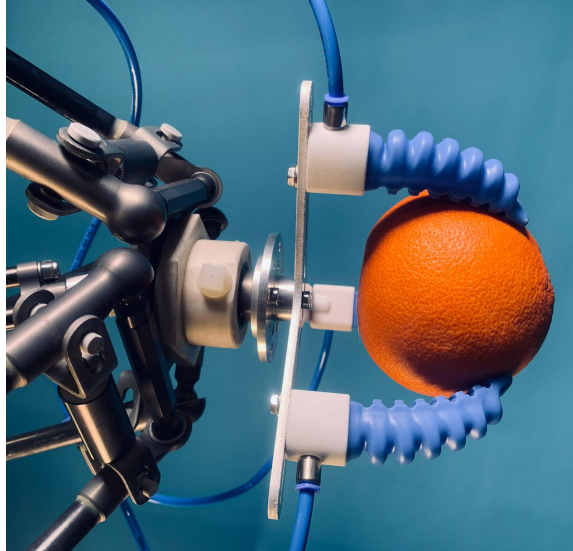
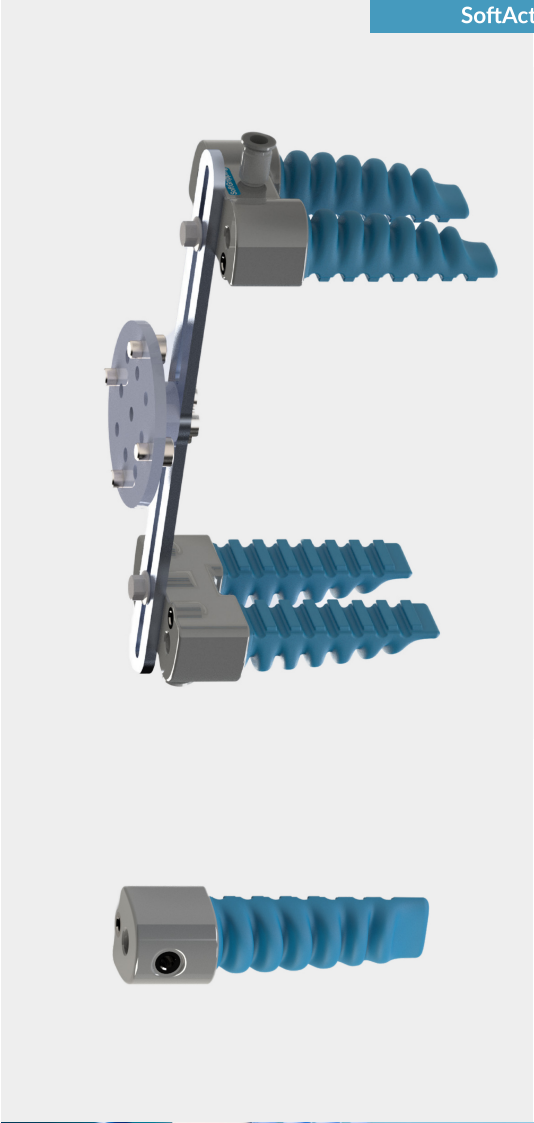

SoftActuator

You need a more flexible gripper? Do you want to modify the gripper as you go? Or you want to integrate SoftActuators into your own handling device?

SoftActuators are the right choice for you! Build up your personal gripper out of SoftActuators and attachment plates and a robot connector.



- Fits to all SoftGripping plates and profiles
- High speed pick and place applications
- Custom actuators are available (number of fingers and finger distance)

Get the CAD-models of the SoftActuators and integrate it into your design.

www.soft-gripping.com

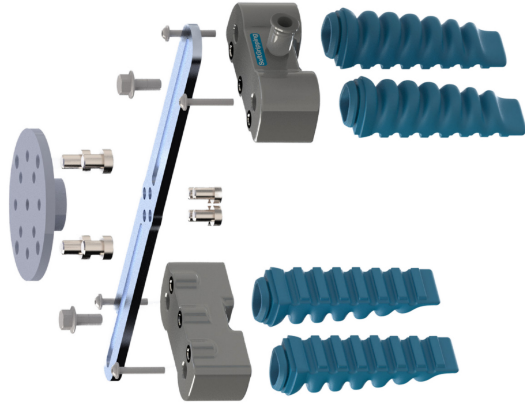

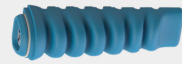

SoftGripping Finger

Art.No. SG.F1.60
Mass 20 g

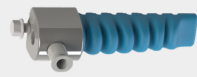
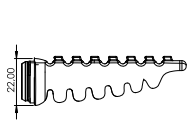
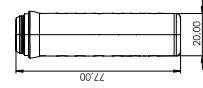

1-Finger SoftActuator

Art.No. SG.AN.F1.S60
Mass 40 g

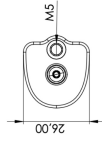
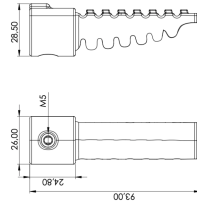

2-Finger SoftActuator

Art.No. SG.AN.F2.S60
Mass 100 g

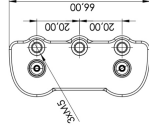
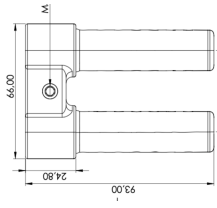

3-Finger SoftActuator

Art.No. SG.AN.F3.S60
Mass 120 g

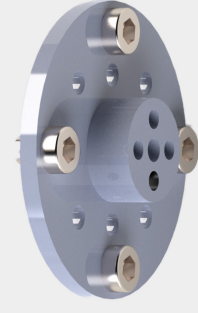
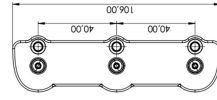
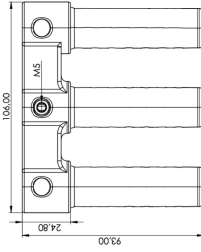

Universal Plate Robot Adapter

ISO 9409-A31.5
ISO 9409-A40
ISO 9409-A50
Art.No. SG.AN.R50
Mass 80 g

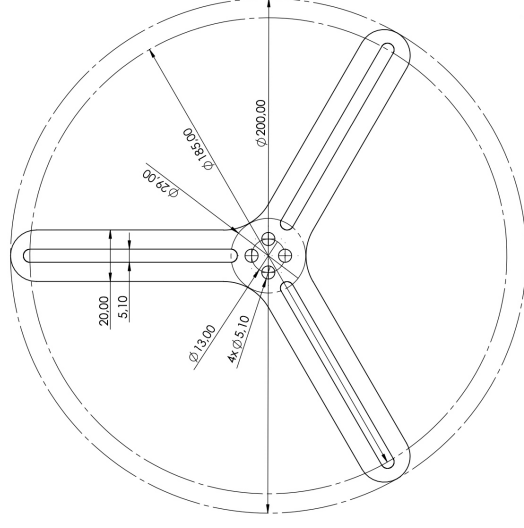
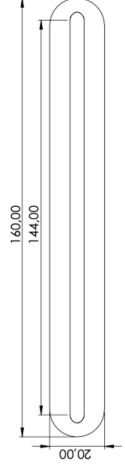

Construction Plate

Art.No. SG.AN.P1.A144
Mass 30 g



2 Arm Plate

Art.No. SG.AN.P2.A185
Mass 40 g



3 Arm Plate

Art.No. SG.AN.P3.A185
Mass 50 g



4 Arm Plate

Art.No. SG.AN.P4.A185
Mass 60 g



6 Arm Plate

Art.No. SG.AN.P6.A185
Mass 75 g



8 Arm Plate

Art.No. SG.AN.P8.A185
Mass 90 g



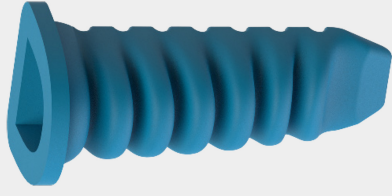
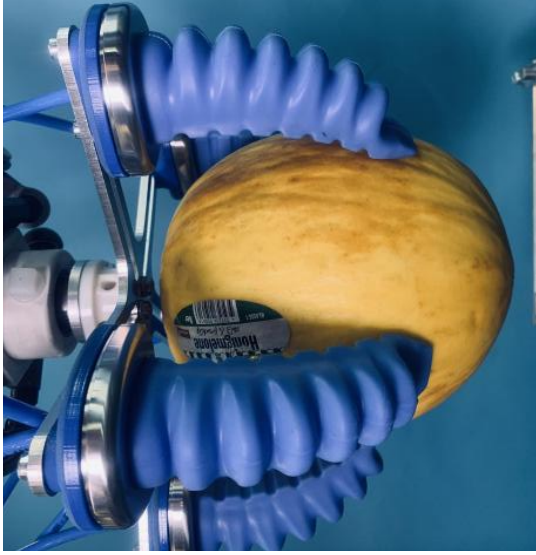

GorillaFinger

Art.No. SG.FG.605

Finger material	Silicone FDA
Mass	42 g
Pressure range	-0.3 ... 1.0 bar
Gripping force	1.0 bar: 11.0 N
Durability @1.3 bar 0.5 Hz	>10 million cycles
Gripping speed	<50 ms

SoftActuator - GorillaFinger

For even higher payloads, our GorillaFingers are the perfect choice. This includes a handling of netted or bagged products like potatoes, apples, carrots or onions. The typical weight of the products handled by this larger fingers is 3 kg.

Other products include bottles, melons, cauliflowers and other rather large produce. The bigger finger surface is ideal for handling doughballs.

Like with standard SoftActuators, you can build up your personal gripper out of GorillaFingers, attachment plates and a robot connector.



- Safe collaboration
- Fault tolerant gripping
- High-speed capable
- Optimized durability
- FDA approved material
- Optional: detectable material available
- Gripping differently shaped products with one gripper
- Big gripping surface, high gripping strength

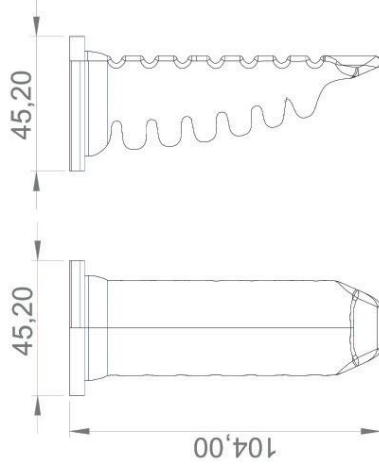

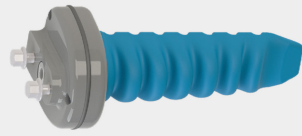

1-Finger GorillaFinger SoftActuator

Art.No. SG.AG.F1.60
Mass 170 g

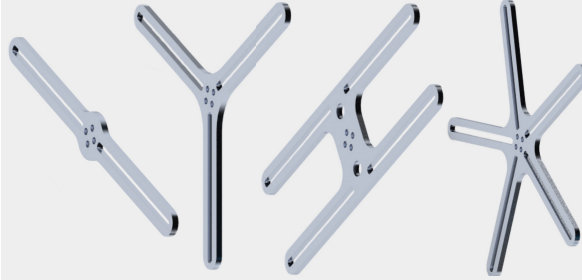
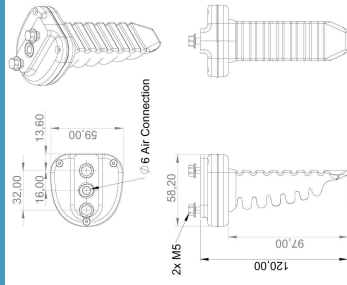

2 Arm Plate

Art.No. SG.AG.P2.A240
Mass 80 g

3 Arm Plate

Art.No. SG.AG.C3.A240
Mass 100 g

4 Arm Plate

Art.No. SG.AG.P4.A240
Mass 160 g

5 Arm Plate

Art.No. SG.AG.C5.A240
Mass 160 g

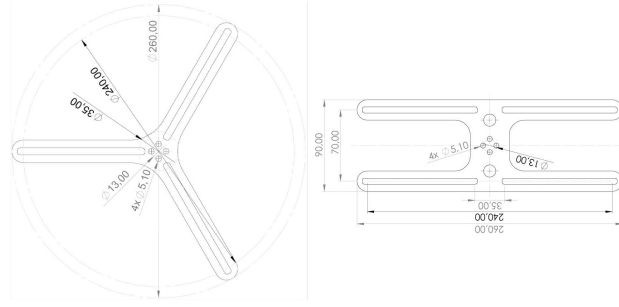

GorillaFinger Engineering Kit

Art.No. SG.GE.B5

A kit with 5 GorillaFingers and a set of plates for customization and adapters that fit all standard ISO flanges. Perfect for larger and heavier goods, bags and nets.



Engineering Kit

Art.No. SG.AP.B6

Our Engineering Kit a great choice for your experimentation needs. The HumanFingers are great for small and medium sized objects and tight spaces.

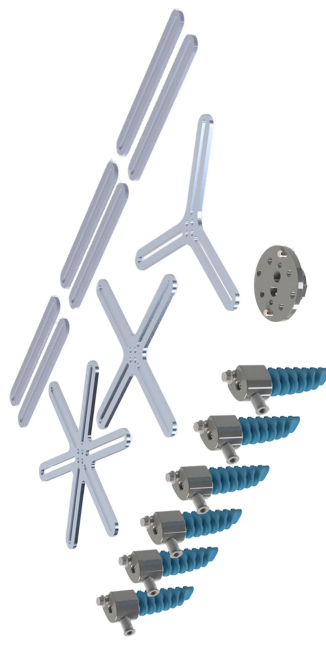



Release

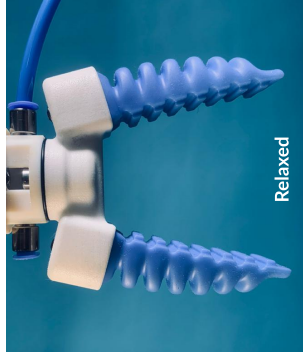

Relaxed

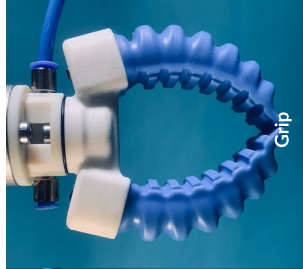

Grip

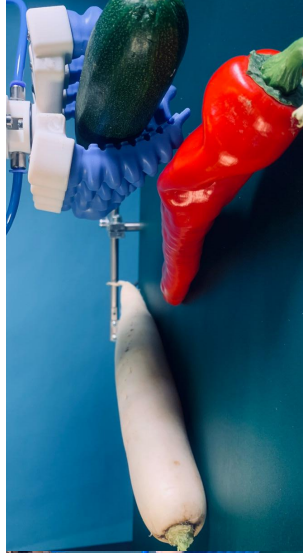
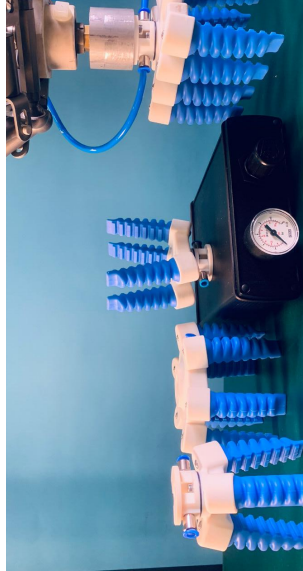

SoftGripping Controlbox

The Controlbox can be used to operate SoftGripper and SoftActuator. It has two outputs for air supply at the back panel. One for the vacuum suction cup and one for the fingers.

At the front panel, you can adjust the maximum output pressure according to your requirements and monitor the pressure output. With digital signals via the signal connector you can switch between three states for the fingers: grip, release or relaxed. The suction cup can be switched between grip and release.

- Suitable for High Speed Industrial Applications
- Robot Applications
- 1 Channel for Gripping Fingers: grip, release and relax
- 1 Channel for Suction Cup

Controlbox	VP-V
Art.No.	SG.BP.2V.C3
Input Pressure	4-8 bar
Output Pressure Finger	0...1.5 bar
Output Pressure Vacuum Cup	-0.7 bar
Switching Speed	<20 ms
Input Pressure Tube	8 mm
Output Pressure Tube	8 mm
Digital Input	3x 24 V DC
Signal Connector	M12 IEC 61076-2-101



SoftGripping Pump

The Pump can be used to operate SoftGripper if you have no central air pressure supply. It has one pressure outlet for the gripper. With digital signals you can switch between three states for the fingers: grip, release and relaxed. At the front panel, you can adjust the maximum output pressure according to your requirements and monitor the pressure output.

- Suitable for Mobile Applications
- Integrated Pump
- 1 Channel for Gripping Fingers: grip, release and relax

Controlbox	P
Art.No.	SG.BP.1P.C1
Output Pressure Finger	-0.5...3.0 bar
Output Pressure Tube	6 mm
Digital Input	3x 24 V DC
Signal Connector	M12 IEC 61076-2-101



Your Notes

Your Notes
